



THE OFFICIAL NATIONAL ORGAN OF THE G.A.R. HISTORIANS & COLLECTORS

Vol. 1 - No. 6

South Lyon, Michigan - April 1981

\$10.00 per annum

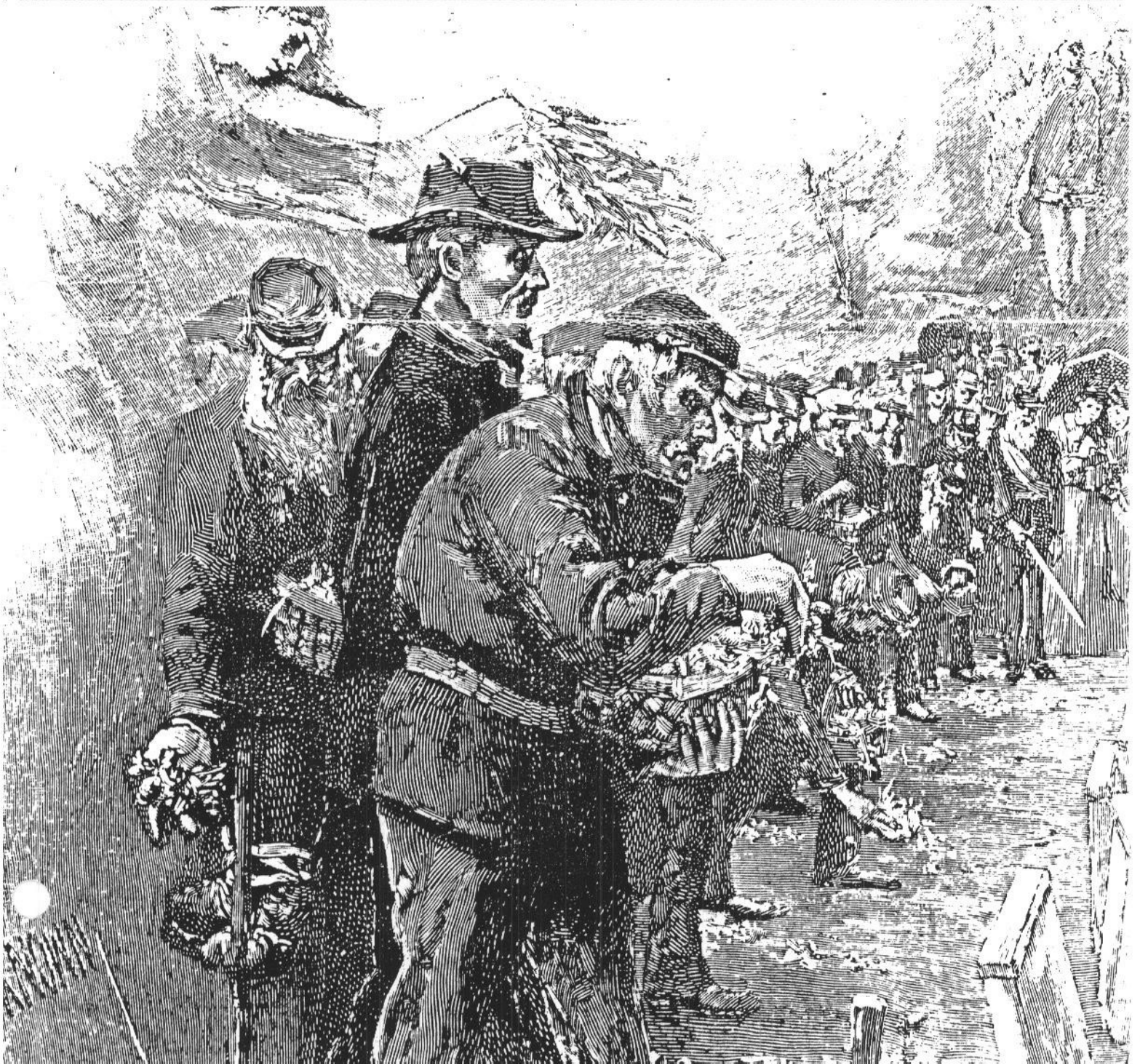

THE GREAT REPUBLIC®

Published six times a year in South Lyon, Michigan by Roger L. Heiple. All letters and communications to this office must be addressed to: Roger L. Heiple, THE GREAT REPUBLIC, P.O. Box 16 South Lyon, Michigan. 48178.

Roger L. Heiple: Editor and Publisher
Warren Barber III: Associate Editor
David J. Klinepeter: Associate Editor
Robert C. Marcotte: Research Mgr.- GAR hall registration.

One year subscription (June to April) mailed first class.....\$10.00
 Single copies..... 1.50
 Bulk sales.....price on request.....

COPYRIGHT 1981

LETTERS TO THE EDITOR

Dear Roger

Thank you a million for that interesting material, especially the nice hoost for my book and for the delightfully less-than-perfect banner.

When you review my book, I do hope that you will send me a copy. I was very happy about the favorable reviews that appeared at the time of its publication, but didn't think it would ever be mentioned in print again.

How I wish that I could attend your first encampment! But there is no chance -- I shall be busy with medical checkups and eye drops for some time after surgery.

Your project fascinates me, and I wish you all success in it.
Sincerely Mary Dearing.

EDITORIAL COMMENTS

With this issue the first volume ends. Throughout the year I have had the opportunity to meet with so many of you from Mass. to Calif. G.A.R. collecting has just started to attract new people, and we the "old time" collectors need to be aware of this growing GAR interest. It is important that the wonderful spirit of cooperation and helping continue as the numbers grow. I wish in some way this paper can provide meeting ground for this scattered group. With this in mind, I have printed the Code of Ethics from the Orders and Medals Society of America in this issue.

As you look back through the past issues of the Great Republic, I hope you can see the growth. Your comments are always welcome and constructive criticism is necessary to improve.

This paper started because there was a need to provide information on the so many areas of the GAR. Everyone is part of this project, so your contribution is still necessary. If you have a idea for an article let me know. If you wish to join the GAR Dept. listing project - write. Keep a eye out for those GAR halls and let Bob Marcotte know.

Thank you for the help.

RLH

PROJECTS - Post Registration by Departments

Volunteers are needed to complete a listing of Posts within each Department. This would include charter date, largest number of members, closing date, and other interesting facts on the post. Departments taken so far include the following:

Massachusetts	Hank McGonagle
Illinois	Earl Bartholomew
Michigan	Warren Barber III
New York	John Bellinger

Still plenty of Departments left.

EDITORIAL CREDITS FOR THIS ISSUE

Cover — Fred Kloster (Harpers)
 Uniforms for Boys in Blue — Wisc. Vets. Museum
 Sommer Badge Circular — WRC Museum
 Code of Ethics — Society of Orders and Medals
 Lee's Patent Badge — Iowa State Historical Museum

ROLL OF RIBBON LOCATED THAT APPROXIMATES THE YELLOW NATIONAL DELEGATE

Years of looking in old ribbon shops may have finally paid off. An old roll of silk ribbon has been located that is the same color and width as the national GAR encampment ribbons. The lines in the weave are a little finer, with the texture similar to the solid color membership silk ribbon. It looks very good as a replacement ribbon for most of the national medals. Because of the age and condition (dirty) when found, the ribbon is being cleaned and pressed with a small amount of size being added. The cost of the roll was \$30 and cleaning, pressing, and resizing almost as much. This puts the price, with postage, to \$3.00 a yard. You should get 6 ribbon pieces per yard and that shouldn't dent the pocketbook too bad. With just a limited amount of ribbon, orders will be limited to 3 yards. The roll will be at the registration table in Ashland for inspection.

PREVIEW OF FUTURE ISSUES

The next issue will feature an article on the Southern Cross of Honor. It will include information on its origin, early manufacture, requirements of issue, and all the other information so hard to dig up.

An article on the Department officer badges will appear in the next issue, followed at a latter date with the National officer badges.

In the works is an article on St. Cloud, Fla. It was the veterans community that was sponsored by The National Tribune in 1909. Anyone with a copy of The National Tribune that advertises the community is asked to send in a photocopy to this office.

Bob Marcotte is working on an article about the General Landers Post in Lynn, Mass. This is one of the most beautiful Posts still in existence today. His article will most certainly include an interview with Mr. GAR at the Lynn Post Hall.

The advertising flyer reproduced below has been provided by the Wisconsin Veterans Museum in Madison. It represents a very important document for many reasons. First, it is unusual to find any paper items from the 1870's with regard to the G.A.R. Secondly, the illustrations show early uniforms of the order, which follow Civil War uniform regulation (note four buttons on the sack coat and cavalry/artillery jacket) rather than the five button coats of the Indian War regulations.

UNIFORMS FOR BOYS IN BLUE.

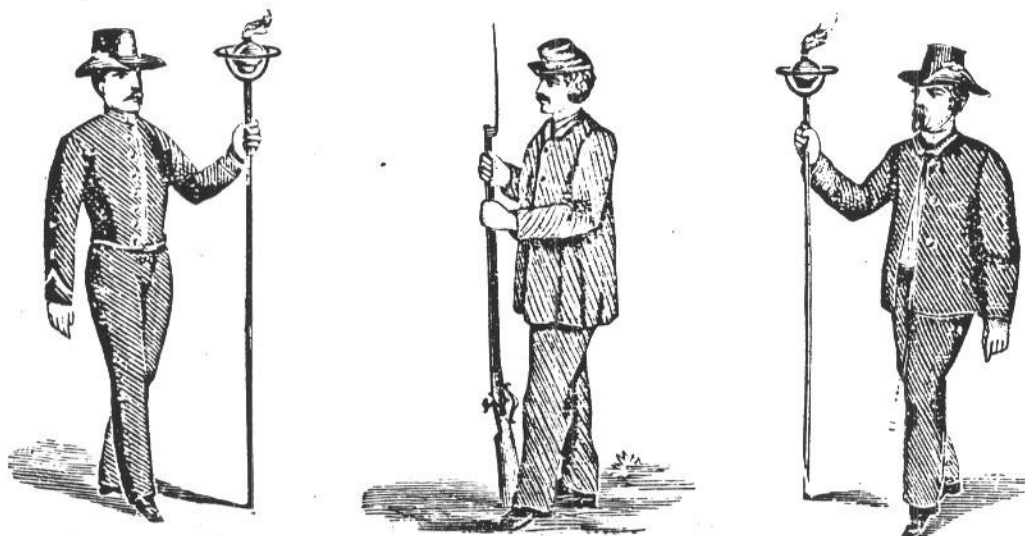

The above cuts represent our Campaign Uniforms for 1876.

The National Uniform for this Centennial year is most appropriate.

This Uniform has all the old Army associations to commend it.

It is the Uniform adopted by the Grand Army of the Republic, and can be used by that body after the political campaign is over.

It can be used for Military organizations. By changing the buttons, it can be used as a citizen's dress, and is worth twice what it costs to wear out.

PRICES.

Per Suit.

ARMY FELT HAT (Trimmed with Cord and Eagle),	ARMY BLOUSE, and TORCH,	- \$2.50
ARMY FELT HAT " " "	ARTILLERY JACKET, and TORCH,	2.50
ARMY FELT HAT " " "	CAVALRY JACKET, and TORCH,	- 2.50
ARMY CAP,	JACKET or BLOUSE, and TORCH,	2.50

Orders Promptly Filled. Terms Cash.

PITKIN & THOMAS,

71 North Second St., Philadelphia, Pa.

PITKIN, WATERBURY & CO.,

EXCERPTS FROM PROF. JAY S. HOAR'S STUDY
SUNSET AND DUSK OF THE BLUE AND THE GRAY

FRANCIS MONROE BROWN 1842 - 1943

It is 3:00 P.M. on the warm afternoon of Saturday, June 7, 1980, in Kansas City, Kansas. The writer is walking north on Fifth Street until he hits Quindaro Boulevard, where he will walk two blocks east to keep his appointment, of a year's standing, with a Civil War widow - one of forty-four getting a federal pension. Forty years and six months younger than the lady who has been a widow most of his lifetime, the writer is overjoyed for the privilege at hand. In just a few minutes he sees her American flag flying in the front yard at 2111 Springfield, he sees her in the doorway, a walker cane held firmly - **Mattie (Davis Thomas) Brown, 87, and all smiles.**

Without hesitation, even though few have introduced the topic in recent years, **Mattie** with pleasure retells details Uncle Frank shared with his last family—

He witnessed the Lincoln-Douglas Debate in northern Illinois and was so glad Lincoln won, you know, like that, cause it helped him later to be president. Uncle Frank was an abolitionist. He wanted to join the army from Illinois, but they wouldn't accept him there where he lived. So he got on a train and the conductor let him ride in his seat up front and not have to pay, and he went to the Brooklyn Navy Yard. He had learned to barber by then as he was twenty-one. He went on the Receiving Ship NORTH CAROLINA. His Captain was Capt. Barne. He was a First Class Boy. Afterwoods he was on other ships - USS GLAUCUS, AUGUSTA and LENAPEE — but mostly he was on the flagship HARTFORD where he was Adm. Farragut's messenger and sometimes barber. Farragut was a swearer too. —

"Dad Brown", as his Kansas City neighborhood all knew him from 1914 on, became a familiar and beloved figure. He went his rounds - the grocery on North 5th where he bought Folgers coffee, liking it mornings with cream and "on the sweet side"; the barber shop a block or so farther along where he got his shaves and swapped stories; and the corner drugstore at 5th. and Quindaro, where, on the spur of the moment, he often treated friends and children to refreshments, where, too, he usually replenished his "Model" pipe tobacco.

His \$12 - a - month pension (Certificate No. 34,112) of 1916 rose gradually, often stepping up on birthday anniversaries to \$21 in 1916, to \$27 in 1921, to \$50 in 1924, to \$65 in 1926, to \$75 in 1930, and finally to \$100 about 1938. Dad Brown was a member of Trinity A.M.E. Church, where **Mattie** for years taught the Cradle Roll Department. (**Mattie** even took two psychology courses in adult education to improve her leadership in Sunday school.) Dad was chaplain for the Sumner W.R.C. and **Mattie** was treasurer until its disbandment in the late 1930's. Their most memorable occasion together came in late June 1938. They were invited to the 75th. Battle Reunion of the Blue and Gray at Gettysburg as guests of the U.S. Government. Traveling on three railroads beginning at 7:00 p.m. June 27th. on the Atchison, Topeka and Santa Fe as far as Chicago, they took the Pullmans all the way east. As they got nearer the old battlefield, the special trains kept adding cars. **Mattie** and Dad Brown, then 95½, besides their tickets, received a per diem allowance of \$9 each for meals and incidental travel expenses while enroute to and from Gettysburg. Each was limited to one piece of hand baggage, not to exceed fifty pounds. Uncle Frank slept in the lower berth while **Mattie**, as attendant, slept in the upper one. The Browns thoroughly enjoyed the entire affair and shook hands with F.D.R. A few minutes before departing on their train, **Mattie** purchased a three foot panoramic photograph of the tent city, and it is framed on her livingroom wall today.

Dad Brown was a great hand for getting to the Civil War reunions, particularly to those of the Kansas Department of the G.A.R., as at Ottawa in May 1937 where he knew all the other fifteen Kansans. Yes, he was one of the comrades and personally knew many of the

late Boys in Blue, and on the national level too. He was attending the nationals as late as the 76th. in Indianapolis during September 1942 when he was but a month from his 100th. birthday. Only three of the fifty-two attending were older than Dad Brown. Those last years his closest buddies who had served in Black regiments were Rev. Barney Stone of Noblesville, Indiana; James H. Lewis of Chicago; Pryor Williams of 2037 North 5th. St., just a few blocks away; Pryor who "went on in" † about 1940, and finally, his friend, George W. Johnson, across the Kansas River in "K.C. - Mo."

Dad Brown didn't show his age but seemed to be "a grand Old Rascal made of whit leather" as his nephew, Edgar R. Tillman, of Chicago, liked to put it. He radioed, seldom missing "Amos 'n Andy," prize fights, or baseball games. The usual high volume offset his fading hearing. On his century day a neighborhood party had friends and well-wishers in for cake and ice cream. One of the ladies cried that evening just to think "how he had fought for his country so many years ago." A piece of that 100th. birthday cake in a fancy butter bowl sits today in **Mattie's** chinacloset. She has kept cherished mementos - her Gettysburg Attendant's badge, old reunion photos, Uncle Frank's portrait and medals, his funeral flag, birthday cards, letters, a cigar box of old tobacco pipes and the knife he cleaned them with.

He died there in the front room to year left as you enter.

To have met her, listened to her, known her but briefly is to raise the meaning of the Stars and Stripes, is to translate that ever difficult (sometimes awkward) abstract *Patriotism* up to its rare, rightful grand heights. Of her many achievements, perhaps her greatest was bringing much happiness into the tenth decade of a standout among the old Blue, making it possible for Uncle Frank to be one of Kansas' last twenty Civil War men, one of the last fifteen survivors of the old Union Navy.

† Passed on to his reward

Because this material is work in progress the editor asks that it not be copied, printed, published or distributed without the author's written permission. Prof. Jay S. Hoar may be contacted at the following address. Star Route Temple Rd., Farmington, Maine, 04938.

Prof. Hoar has published *New England's Last Civil War Veterans*, and it's available from him for \$6.95 plus 55 cents postage.



1ST. ENCAMPMENT OF THE G.A.R.
COLLECTORS & HISTORIANS

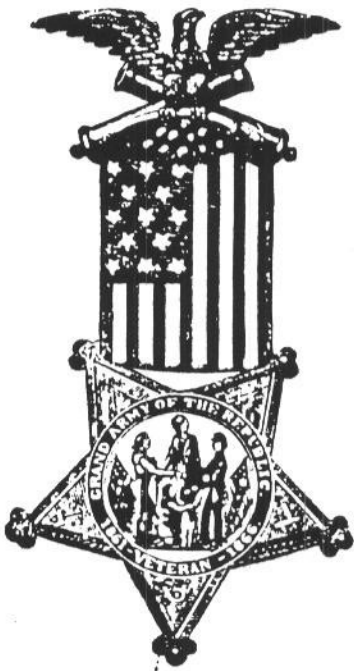

Held at the Ohio Civil War Relic and Collectors Show in Ashland, Ohio.

A special section of tables is being set aside for GAR displays and sales. A prize will be awarded to Best of Show - GAR.

SCHEDULE OF EVENTS

April 24 - Friday evening.

Friday night set up. 6 to 9 p.m. only.
Pick-up exhibitor's packet
Register with GAR information table

April 25 Saturday

7 a.m. to 9 a.m. Exhibitors only
9 a.m. to 5 p.m. Show hours
GAR registration table open all day
5 p.m. to 7 p.m. Dinner
7 p.m. to 10 p.m. GAR Collectors
Meeting in Convocation Center.

April 26 Sunday

7 a.m. to 9 a.m. Exhibitors only
9 a.m. to 5 p.m. Show hours
GAR registration table open all day

THE LARGEST GROUP OF G.A.R. MATERIALS EVER OFFERED AT A COLLECTORS SHOW

Ten tables of G.A.R. materials will be offered for sale at this show. Three tables of display will be shown. This is the minimum number, because these are the figures for the paid table reservations at this early date. It is hoped that 5 more sale tables will be reserved. G.A.R. items will be also offered by the many other Civil War sale tables. Dave Klinepeter will have two tables for display of his outstanding collection of membership and officer badges. There will also be a display of a COMPLETE National Encampment Delegate set from 1883 to 1949. This is the only known set of these beautiful medals and your chance to see what some of the rare early ones look like.



Revolutionary 1776 thru
1898 Indian Wars

Saturday, April 25, (9am-5pm)
Sunday, April 26, 1981 (9am-3pm)

Open to the public at
ASHLAND COLLEGE
CONVOCATION CENTER

Claremont Avenue, Ashland, Ohio

Table Set-up Friday evening, April 24,
1981, (6pm-9pm); Saturday and Sun-
day, April 25 & 26, 1981, (7am-9am).
Bonded Security provided both Friday
and Saturday nights. For tables or information, contact:

John Solinger: (419) 683-1091

Don Williams: (419) 289-3120

Post Office Box 248 Crestline, Ohio 44827 1083 Oak Hill Circle Ashland, Ohio 44805

ADMISSION - \$1.50 Adults

Children under 16 admitted Free, when accompanied by Parent or Guardian.

150 Tables Available - Strictly Military Items, Relics and RELATED Memorabilia for Buy, Sell & Trade from the Period of 1776 thru 1898 Including Books, Pictures & Etc. Reproduction Items Permitted if so Marked.

6 Foot Tables: \$10.00 one day
\$12.00 two days

8 Foot Tables: \$12.00 one day
\$15.00 two days

A SPECIAL RIBBON BEING PREPARED FOR THE ASHLAND SHOW - 1st. Annual Encampment of the G.A.R. Historians and Collectors to be printed on a ribbon as identification of the GAR members. Cost of this ribbon will be \$1.00 and be available at the GAR registration table. For those unable to be in attendance the remaining ribbons will be made available for \$1.00 plus .25 postage. Requests for these ribbons will held in order of receipt at the office of the Great Republic, and distributed after the show until the supply is exhausted.

COLLECTORS MEETING SATURDAY NIGHT will feature a slide presentation on the early history of the G.A.R. Slides showing medals from the best collections will present outstanding items from the American Numismatics Society, Smithsonian, the GAR Memorial Hall in Madison, Wisc., Chicago Public Library - Special Collections, and many others. Collectors are encouraged to bring a couple of their best items for an hour of "show n' tell". This will give those who don't have tables to bring something. Dave Klinepeter will take over the program at about 10 p.m. and lead the group to a small pub for a social hour.

FREE APPRAISALS AND IDENTIFICATION TO BE MADE BY THE STAFF OF THE GREAT REPUBLIC

The G.A.R. registration table will serve as the location for a free appraisal and identification service. The staff of the Great Republic will be available to assist anyone with a G.A.R. related item. They will attempt to give identification of the item and outline a relative value.

DORMITORY HOUSING AVAILABLE IN ANDREWS HALL at special low rate. Most of the exhibitors stay in the dormitory and rate it good (reasonable). Information available from Don Williams.

Can be made
The Badges can be had



NO. 96

Dear Sir:—

Badge No. 96 is a illustration of a badge made suitable for Memorial Day to wear in parade or in decorating the graves of our noble soldiers and sailors. It is now the custom in a great many cities and towns to give these memorial badges to the school children to assist in decorating the graves and at the same time encourage them to take an interest in the work in every way.

You will also find some designs illustrated in this circular, from which you can make a selection in case this should not meet with your expectation.

PRICES

50 Badges.....	5c each	500 Badges.....	3c each
100 Badges.....	3 3/4c each	1000 Badges.....	2 1/4c each
200 Badges.....	3 1/4c each	2000 Badges.....	2c each

We also make a handsome line of reunion badges at very low prices. Should you be in the market for anything in our line we would be pleased to hear from you. We guarantee perfect satisfaction and prompt service.

Respectfully yours,
THE SOMMER BADGE MFG. CO.,
Newark, N. J.

P. S.—Should these circulars and sample be of no use to you, would you kindly hand them to some society or association in your city and accept our most hearty thanks?

★ Victory Year 1919 Circular ★



RIBBON & METAL BADGES
CELLULOID BUTTONS
FLAGS

Free sample on request

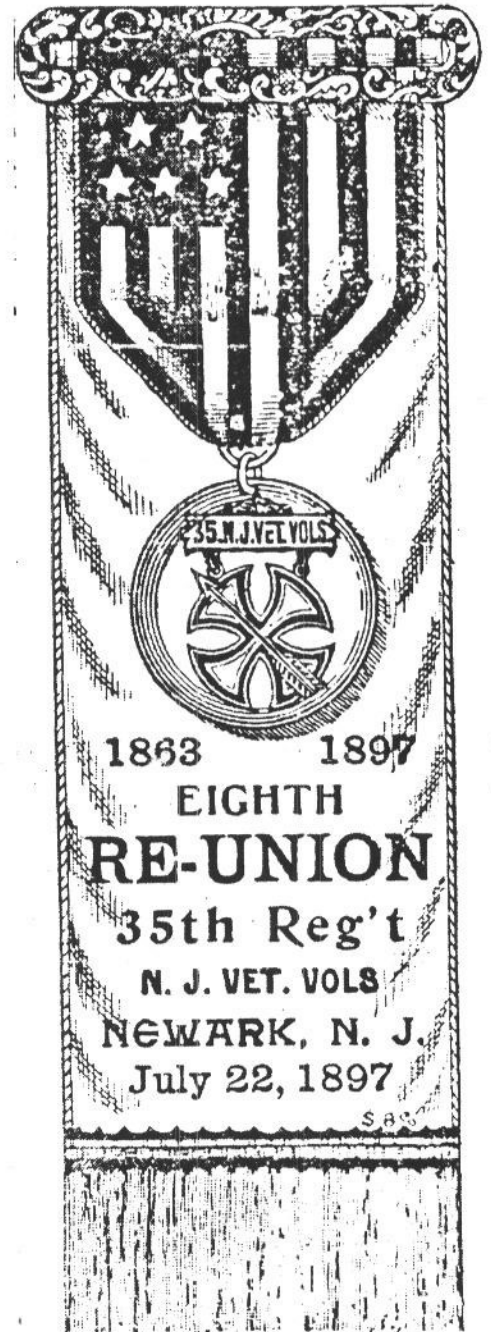

115 6014
Badge No. 6014
25 Cents each

Suitable for Memorial Day and Reunions

any color of ribbon with any lettering stamped on same with any emblem in buttons.



Badge No. 1919
15 Cents Each



Badge No. 904
18 Cents Each



Badge No. 6004
20 Cents Each



3BN-GAR COLUMN

A REGULAR COLUMN SHARING
THE RESEARCH OF THE EARLY
GAR ORGANIZATION & EMBLEM

POSSIBLE EARLY PHOTO OF B. F. STEPHENSON FOUND IN G. A. R. PHOTO ABLBUM

With the purchase of an elaborate GAR memorial photo album came an interesting and possibly rare cabinet photo of B.F. Stephenson. The mounted photo has been trimmed to 4¼ X 5½ inches. It was printed by the ablumen paper process and is now yellowed with age. The reverse side has two U.S. Inter Revenue tax stamps. In the book, *Collection, Use, and Care of Historical Photographs*, by Robert Weinstein and Larry Booth, they state "U.S. Tax Stamps required from 1864 to 1866." 1865 or 1866 would appear to be the correct time period for the photograph. The subject has his Civil War uniform on and the major rank straps on the uniform futher confirm the indentification of Stephenson.



B.F. Stephenson ????????

The evidence appears to confirm that this is a genuine photo of Stephenson in uniform, and is an important historical photograph. It has been printed here so that the readers may comment and help complete this tentative indentification.

RLH



U.S. Tax Revenue Stamps

DELEGATE BADGES

18th. NATIONAL ENCAMPMENT BADGE
MINNEAPOLIS, MINNESOTA 1884



Mfg. of badge:	not known
Size of badge:	not known
Ribbon	not known

After exhaustive research with respect to a Delegates badge for the Minneapolis Encampment, it has now been suggested that it is quite possible and probable that no badge was ever manufactured.

The following criteria used on the other badges has been applied to the research on the 1884 badge.

Is there an 1884 badge in any of the major public collections (Smithsonian, ANA, various State Historical collection, WRC Museum, Post collections, Daughters Museum)? _____ NO

Is there an 1884 badge in any of the private collections (Klinepeter, Barber, Attwood, etc.)? _____ NO

Is there reference to a badge in the GAR Encampment Journal, Beath's History, or any other GAR publication? _____ NO

Has there been any photographs identified of GAR veterans with an 1884 badge on? _____ NO

Without one clue in all this research to give some hope, that an 1884 Delegates badge could be found, it has been resolved that the status of the 1884 badge is —NONE WERE PRODUCED

It is quite possible that a badge was not planned for the 1884 Encampment. 1883 was the first year that a badge was produced, and it was a gift from a private citizen in Colorado. (William Hammill of Georgetown) The offer to produce a Delegates badge may not have been made in 1884, but its absence surely may have had a positive effect on latter encampments. It is more than likely that the absence of the badge in 1884 sparked future Encampment committees to offer a delegates badge as part of the inducement for selecting a particular city. The Delegates badge became an annual and regular part of the Encampment from 1885 on.

Anyone that can provide a clue that a badge was produced is urged to write this office. The discovery of an 1884 Delegates badge would indeed be an important event and it would be a very rare item.

The following CODE OF ETHICS has been adopted by the Orders and Medals Society of America. It is a fine example of effort to keep medal collecting honorable. It is preprinted here as a guide which the subscribers of the GREAT REPUBLIC should be aware. Those who are not already members of the Society may write this office for applications for membership. Dues of \$15.00 a year include a subscription to the monthly journal THE MEDAL COLLECTOR.

CODE OF ETHICS

OF THE ORDERS AND MEDALS SOCIETY OF AMERICA

In order to promote the objectives of the Society and the interests of its members, the following Code of Ethics shall govern the conduct of all members, present and future, as well as that of any guests members may introduce to a Society meeting.

- I. It shall be considered unethical to manufacture, cause to be manufactured, to offer, sell, trade or to display items which are reproductions, copies or restrikes of original orders of merit, medallic awards or associated collectable material, unless such reproduced material is clearly identified as such.
- II. It shall be unethical to alter any award or collectable item by the addition of spurious markings or namings, by changing metallic finishes, by newly assembling or reassembling components, or practicing any other means of deception which changes the status of an original piece.
- III. In recognition of the responsibility of the Society to new members, it shall be the privilege of first-year members to request the nullification of any transaction entered into with another member within 45 days of such transaction.

Under *The Medal Collector* advertising policy, any member may request the nullification of a mail order transaction within 15 days of receipt of material judged unsatisfactorily represented in an advertisement carrying an OMSA membership number.

It shall be considered unethical to refuse either class of request, or to fail to return promptly any funds or merchandise which may have changed hands in such transactions.

- IV. Other actions considered to be a violation of this Code of Ethics are:

Avoidance of obligations undertaken in good faith; unjustly defaming the character of another member; interfering with the operation of activities of the Society or violating its bylaws; committing a criminal offence, or failing to respond to official Society communications pertaining to this Code of Ethics.

APPLICATION OF THE CODE

- I. Any member may bring a complaint of a violation of the code, such complaint to be reported with full details to the Secretary of the Society.
- II. The Secretary will solicit a response from the second party, and present all materials to the President for consideration and possible further investigations needed. If the issue cannot be resolved among the parties at this point, the matter will be presented to the Board of Directors for adjudication.
- III. In the event a complaint involves an officer or director of the Society, that officer or director will withdraw from any consideration in the case.

PENALTIES

Penalties resulting from the violation of this Code of Ethics may include: an official warning; probation, with or without suspension of receipt of *The Medal Collector* and/or advertising privileges therein; prohibition of convention attendance, or termination of membership (Expulsion).

HOW TO PROTECT THOSE CHERISHED NATIONAL DELEGATE MEDALS

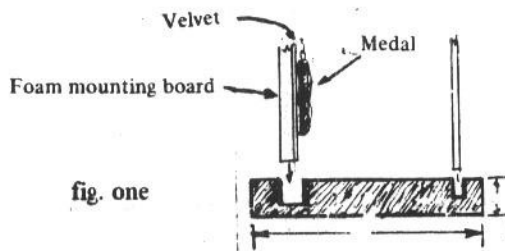
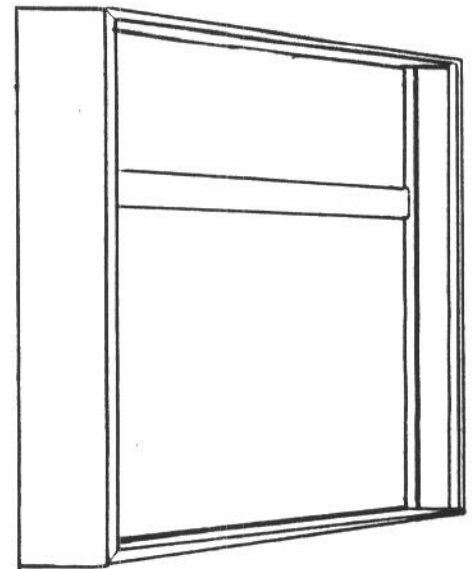
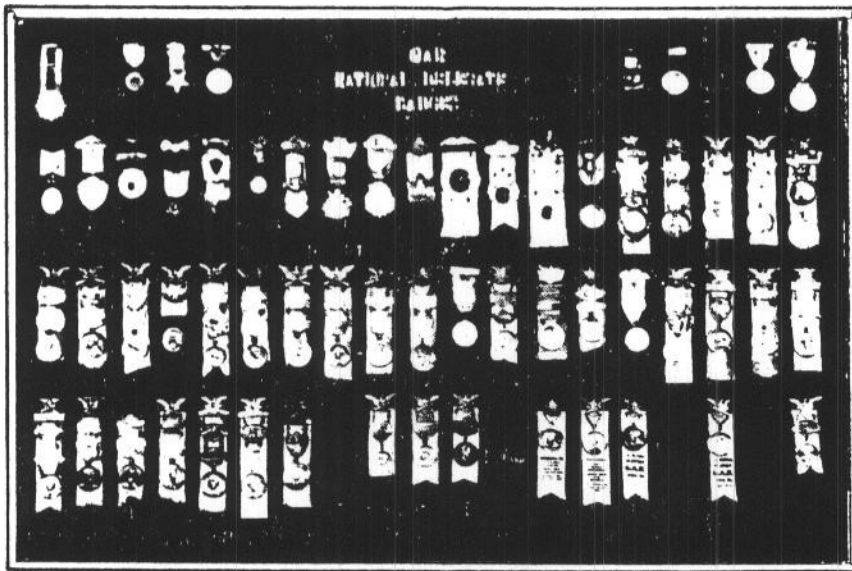

fig. two

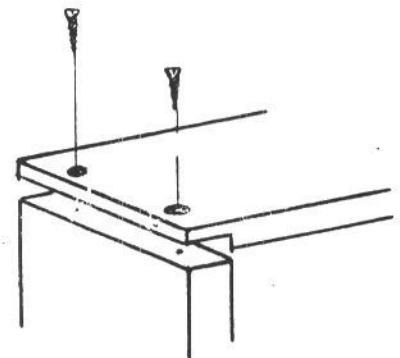
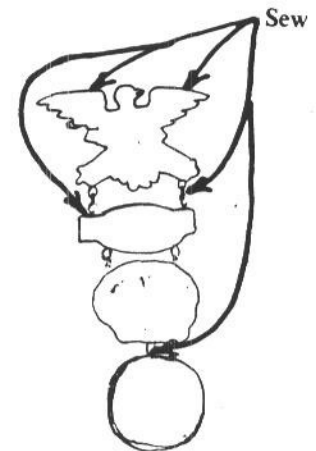

fig. three



After the boards are cut to size, rout the two slots for the mounting board and plastic sheet.(fig. one) The corners are then cut for a lap joint (fig. two). The two bottom corners can be assembled and glued. The top two corners are fitted, but left unglued. The brace is fit to the back with routed notches, and glued. Screws may be used on the brace for added strength. Measure the openings for the plastic and the foam mounting board; Cut the foam board first and fit. Use the foam board as a pattern for the cutting of the plastic. Glue the velvet to the foam board with cement (3M Spray 77 works best). Straight pins with white thread stretched between the pins can be employed for the layout of the medals. Sew the medal on(fig. three). Assemble and hang on the wall with at least two heavy duty hooks and eyes.

List of materials :

- 2 Boards (Oak preferred) 3" X 51"
- 2 Boards(Oak preferred) 3" X 34"
- 1 Board (Oak or pine) for brace in rear 2" X 50½"
- 8 Brass screws No. 10 1½"
- 1 Foam mount board 3/8" 40"X60" trim to case size.
- 2 Yds. of black velvet, min. width 35"
- 1 Sheet of ¼" plastic. Glass can be used , but not recommended.
- 1 Spool of clear nylon thread and needle.

Spacing for the medals ----- 2½" center to center and 9" between the top of one row to another. (fig.4

fig. four

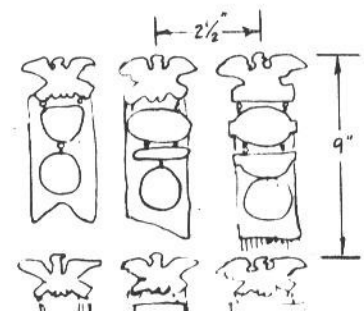

Row One	1883 to 1892
Row Two	1903 to 1911
Row Three	1912 to 1930
Row Four	1931 to 1949

CLASSIFIED

FREE - Everyone that subscribes can have one free classified ad. Words are allowed free, and additional words are .10 each. Count words and address as three words. Ads will be placed in issues as received, depending to earliest postmark. Ads received after classified section is closed will be placed in the next issue.

DISPLAY ADVERTISING RATES

Full page (8 X 10) \$25.00 , Half page (4 X 10, 5 X 8) \$18.00
Quarter page (4 X 5), 2½ X 8) \$12.00. Eighth page (2½ X 4) \$8.00
There is a 40% discount for ads that run for six consecutive issues.

MILITARY PAPER ITEMS Books, Magazines, Documents, Letters, Images at affordable prices. Colonial to WW I. G.A.R. paper items. Bought and Sold. Two different stamps for comprehensive catalog. Gordon Toddy, Historic Paper Americana, 576 Massachusetts Ave., Lunenburg, Ma. 01462.

STATE OWNED MUSEUM wishes contact with other G.A.R. collectors of Civil War and GAR materials, especially from Wis. Will Trade. Wisconsin Memorial Hall Museum, Capital 419 North, Madison, Wi. 53702.

WANTED National officer, Delegate, and Membership badges. Post, State and National. Anything from Indianapolis Indiana (8 National Encampments) 1860, 1891, 1893, 1920, 1921, 1942, 1946, 1949. Robert F. Neidhamer, 624 E. Normal, Fresno, Calif, 93704.

WANTED Indian War Veteran items. Membership badges, etc., for National Indian Veterans, United Indian War Veterans, and Order of Indian Wars. Jerome A. ... 3545 Raleigh Street, Denver, Colorado 80212.

BUY - SELL - TRADE Old military medals UCV and GAR badges, books, personal souvenirs. Describe and price. Want "Triumph and Trials" (55th. Ohio) Osborn. Joe Attwood, 5415 SW 6th. Cape Coral, Fla. 33904

WANTED G.A.R. material from Western and Southern departments. Grand Rapids, Michigan, National Encampments. Warren Barber III, Box 43, Richland, Mi. 49083

WANTED UCV items. Larry G. Moesle, 804 Harriet Ave. N.W. Canton, Ohio 44703.

Subscribe Today!!!

BUY - SELL - TRADE

CIVIL WAR...

- | | | |
|-----------|---------------|----------|
| ★ Books | ★ Guns | ★ Postal |
| ★ Relics | ★ Information | ★ U.C.V. |
| ★ Members | ★ Paper Goods | ★ G.A.R. |

PLUS: Book Reviews. C.W. Battlefield News, C.W. Roundtable News, Genealogical Information and much more.

FREE!! 25 Word Ad in Each Issue for the Life of Your Subscription



\$ 8.00 PER YEAR

P.O. Box 15432 • Philadelphia, Pa. 19149 (SIX BIG ISSUES PER YEAR)

WANTED Information or items of any type dealing with Brooklyn, New York GAR Posts, especially "Rankin Post No. 10 GAR Brooklyn, N.Y." Frank L. Blades R.D. 3 Box 363 Seeley Road, Bridgeton, New Jersey 08302 Phone 609-455-2420

G.A.R. MEDALS BADGES, AND EXONUMIA bought and sold. Write for free auction catalog. Will purchase large collections or single items. Rich Hartzog, P.O. Box 4143 NS, Rockford, Il 61110

FOR SALE Ribbon "Fifth Annual Reunion - Andersonville, Richmond, and other Prisoners - July 2, '78, Wilkes Barre, Pa." Light Blue and in fine condition. Very rare early ribbon of the Ex. Prisoners (1878) \$45.00 J.M. Iovan, 2061 Norfolk, Ann Arbor, Michigan 48103

FOR SALE Display oil portraits on canvas. Oval shape measuring 40" by 48". Most likely used at an Encampment during the 1890's. Each has the name painted at the bottom and a green wreath on each side. These are fine oil portraits but lack the fine details of a portrait art piece. Farragut (minor tear repaired) 350.00, Sheridan \$400.00, Thomas \$500.00, Burnside (minor damage repaired) \$350.00, Hancock \$400.00, Butler (rip repaired) \$300.00, Meade (being restored) \$500.00, Sickles (being restored) \$450.00, Please write for more details if interested. Roger L. Heiple, P.O. Box 16, South Lyon, Mi. 48178

WANTED Gettysburg, Souvenir, Reunion, and Monument Dedication ribbons, badges and medals. Also Paper Items related to Gettysburg. John J. Bellinger, 724 German St., Elmira, N.Y. 14901

WANTED - INFORMATION I need identification of either unit or individual. Would appreciate any help - 2nd. Lt. J.-B. Wetherill, 2nd. Regt. E.M.D.M (c. 1864) Write to: Tom LoPiano Jr., 637 Mill Plain Rd., Fairfield, Ct. 06430

AMERICANA MAIL AUCTION Civil War and GAR items at your price or less. Free copy and information. George M. Rinsland, 4015 Kiimer Ave., Allentown, Pa. 18104.

WANTED Dept of Maine GAR items. Reunion items and badges of the 16th. Maine Inf. Copy of Small's History "The 16th. Maine Regt." James B. Stone, 67 Middle Rd., Rowley RFD, Mass., 01969.

WANTED Any material marked 3BN- GAR. National Delegates Badges 1948, 1947 and before 1890. Also National Journals, Department of Penn. Delegate Badges, various state journals. Officer badges. David J. Klinepeter, 32 South 24th. Street, Harrisburg, Penna., 17103.

WANTED GAR parade canteens - Metal - Ceramic - Glass. Personal, organizational or souvenir of any state plus other GAR memorabilia pertaining to Missouri, especially St. Louis. Also, Missouri UCV items. David V. Radcliffe, 122 N. Kirkwood Rd. Kirkwood, Missuri, 63122.

WANTED UCV, GAR National Encampment Badges, Especially 1896 St. Paul, 1909 Salt Lake City, 1911 Rochester. Also interested in buying a copy of "History of GAR" by Robert Beath. William Ballard, 1970 85th. St. W., Inver Grove Hts., Minn. 55075.

WANTED Pennsylvania GAR items. Any State Regimental, Top bars. National Association Ex-prisoners of war items. GAR canes and swords Describe and price. George Cress, 20 Hilltop Road, Norristown, Pa. 19401

WANTED CW, GAR, IWP, WW1, WW2, USA., Metal insignia, belt plates, buttons, medals, assoc equipt issued to USA Cavalry, Infantry, Artillery, Navy. Reasonably priced items. Elmer O. Jensen, 903 Prospect Ave. Elmhurst, Illinois 60126.

WANTED G.A.R. Dept. of Mass. Items and other New England Dept. material. National and Dept. badges and cavalry reunion ribbons as well. Have items for trade. Hank McGonagle, 26 Broad St., Newburyport, Mass. 01950.

WANTED Originals or copies of letters, diaries, photos or reunion ribbons of Men of the Old 4th. Michigan Infantry. Would like to contact descendants. William F. Heckert, 730 Westminster Lane, Kokomo, Indiana 46901.

RICHARD H. LEE
Co. B 22 Ill. Mt'd Inf'y

JOHN T. GANTZ
Co. F 34th. ILL.



MANUFACTURERS OF

Lee's Patent Designation Badge

OREGON, ILLINOIS.

The above cut represents our Designation Badge which we are manufacturing under Lee's Patent, granted November 11th, 1887. As the reunion season of the past year had about closed before the machinery for the manufacture of these badges was perfected, they were offered for sale at five places only in the United States since their introduction. This, together with an advertisement appearing in the NATIONAL TRIBUNE, one week only, created a demand for them wholly unexpected, and which we were unable to supply, as many comrades, who were unable to obtain badges can testify.

In order to meet the increased demands of the coming season, we have adopted the plan of placing our circular in every Grand Army Post in the United States thus early, that every Comrade may have the opportunity of securing a badge of his Company and Regiment in advance of the reunion season, as it will be impossible while at these gatherings, to supply all who desire them; besides, we can do our work with greater satisfaction to all with skilled hands in the quiet of our office than through inexperienced agents in time of excitement.

Every delegate to the different State and Territorial Encampments should provide himself with one of these badges. The composition of the Badge and letters is brass, gold plated; the letters being securely attached and resting upon an enameled field. Thirty-eight hard enamel stars adorn the border.

Branches of service indicated as follows: Infantry, -blue stars, field and silk ribbon pendant. Artillery - Red stars, field and ribbon. Cavalry - Blue field, stars and yellow ribbon. Marine-"U.S. Navy," with navy blue ribbon.

Price of Badge (sent postpaid) fifty cents. Cash to accompany all orders. If the Badge does not prove satisfactory upon receipt of same, it may be returned and we will refund the full amount.

REFERENCE - First National Bank, Oregon, Illinois.
Yours in F, C, & L.

LEE & GANTZ

Oregon, Ill., Jan. 1st. 1888,



COMRADE:

The accompanying circular is sent you with request that it be read at your next Post meeting, at which time if you will take the order of those who desire a badge, and send same to us, we will allow you agent's commission, as follows: On order for five to ten, ten cents off on each badge, and on each badge in excess of ten, fifteen cents off. Price of badge, 50 cents, cash to accompany order. Remit by money order, bank draft, postal note or express order. Upon receipt of badges if unsatisfactory, return same and we will refund the full amount. If you have not the time to devote to this matter, please hand this circular to some worthy comrade who has.

The actual badges of this style are pictured below.



75th. ILLINOIS INFANTRY Co. C.



85th. ILLINOIS INFANTRY Co. K.



140th. ILLINOIS INFANTRY Co. I.



4th. MICHIGAN INFANTRY Co. I.



Reverse of badge

The ribbons are missing from all the badges shown.

The Lee & Gantz advertising sheet is in the collection of the Iowa State Historical Museum in Des Moines. It explains this little badge that has puzzled collectors for so many years. The Lee badge has been listed as a badge from the Spanish American War and as a political badge. It is now possible to identify and date this badge as a G.A.R. and regimental reunion badge from 1888 to the early 1890's. Most of the examples of the badge are from the Illinois Vol. Regiments. It was never as popular as the silver plated ladder types. Only a few of these badges are found and they are considered an excellent find.

The photographs above are slightly larger than the actual badge. The measured size of the badge is: 19 mm X 157 mm. The badges are in the collection of Roger Heiple.